

---

Item no.: 771-9985/206-201  
Product description: CONNECTION WIRE; PLUG - OPEN WIRE; 5 POLE; 2 m;  
CODING I; e. g. for dimming function (DALI)

---

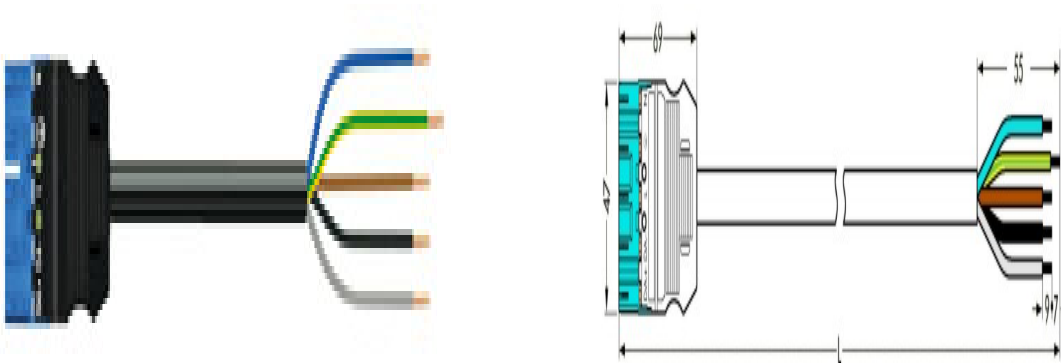

Packing unit 1 piece

Product group	20 (WINSTA)
pole count	5
Cross section to [mm <sup>2</sup> ]	1,5 mm <sup>2</sup>
Cross section to [AWG]	16 AWG
Number of strands	5
Measured voltage EN	400 V
Measured shock voltage	6 kV
Pollution degree	3
Current intensity EN	16 A
Weight	348,432 g
Color	black

© WAGO Kontakttechnik GmbH & Co. KG

Specifications are subject to changes and errors may be expected